

MODEL: NF-521

Your excellent helper in cable test!

Thermal Imager **INSTRUCTION MANUAL**



Your excellent helper in cable test!

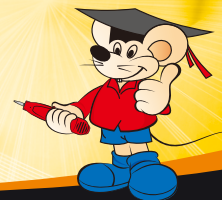

VER: V5



Read the precautions before your operation

- The NF-521 power system is lithium battery.
- Please do not place the device in a location that is dusty, humid, or hot (above -10~45°C).
- Please use a battery that meets the specifications, otherwise the device may be damaged.
- Please do not disassemble the device. Repair and maintenance should be done by a professional staff.
- When not using the device for a long time, please remove the battery inside the test terminal to prevent the battery liquid from leaking out.
- Please do not use this device to detect live power lines (such as 220V power supply lines), the device may be damaged and personal safety may be influenced.
- Please do not perform related operations on the communication line during thunderstorms to prevent lightning strikes and personal safety.

Table of Contents

| | |
|---|-----------|
| Overview..... | 01 |
| 1. Application..... | 02 |
| 2. Packing List..... | 02 |
| 3. Instructions..... | 03 |
| 4. More settings..... | 06 |
| 5. Application instructions..... | 09 |
| 6. Scene application..... | 09 |
| 7. Technical indexes..... | 10 |
| 8. Diagram of Series Products..... | 12 |

Overview

The NF-521 is a thermal imaging camera that combines surface temperature measurement and real-time thermal imaging. The thermal imager is effective in converting thermal radiation images into visible light images. It is mainly used for building diagnostics, industrial leak detection, and electromechanical testing and so on.

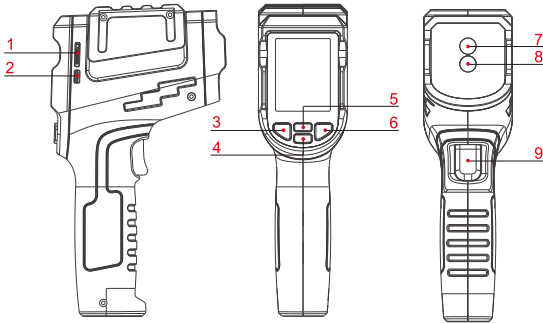

| | | | |
|---|---------------------------|---|-----------------|
| 1 | SD card slot | 2 | USB interface |
| 3 | Power no/off & Return key | 4 | Down key |
| 5 | UP key | 6 | OK&Menu key |
| 7 | Thermometer lens | 8 | Infrared camera |
| 9 | Trigger | | |

1 . Application

- Installation and maintenance of floor heating, radiator and water heater.
- Wireless probe. It accurately locates hidden blockage, clogging inside the pipe and reminds you with a buzzing sound.
- Property maintenance such as air leakage and leakage.
- Residential office and production electricity maintenance.
- Small animal search and investigation in buildings (including termite control).
- Car repair and maintenance inspection.
- Fire and rescue situation investigation.
- Inspection and maintenance of old buildings.



2 . Packing List

| | | |
|---|--|------|
| 1 | Master (included a 16GB TF card & lithium battery) | 1pcs |
| 2 | USB cable, 16GB micro TF card | 1pcs |
| 3 | Carry bag | 1pcs |
| 4 | Manual | 1pcs |
| 5 | Certificate | 1pcs |

3. Instructions

3.1. On / Off

In the shutdown state, press the  key (about 6 seconds) until the welcome interface appears and release to complete the start up.

In the power on state, press the  key (about 3 seconds) when not enter any setting interface, until the shutdown confirmation interface appears. Press the  key to cancel the shutdown and press the  key to confirm the shutdown.

3.2. Up and down key shortcut selection mode

 key (display mode) present in turn: infrared mode / infrared edge detection mode / dual light fusion mode / dual light fusion mode /

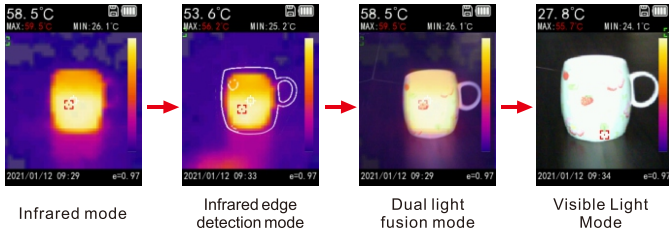

Infrared mode

Infrared edge detection mode

Dual light fusion mode

Visible Light Mode

Color plate switching sequence of NF-521 shown as below

 key (display mode) present in turn: Iron red / Cold color / Black heat / Rainbow / Red heat / White heat / Lava.

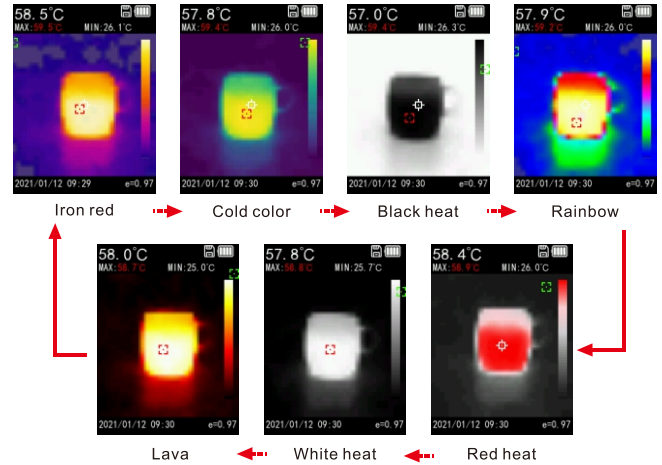

Iron red

Cold color

Black heat

Rainbow

Lava

White heat

Red heat

3.3. Temperature measurement

When not enter any setting interface, the white center point on the screen represents the temperature value of the point, and the numerical value is displayed in the lower left corner of the screen; the red dot represents the maximum temperature of the whole screen, and the numerical value is displayed in the upper left corner.

The green dot represents the lowest temperature of the whole screen, and the numerical value is displayed under the right color board, shown as right side.

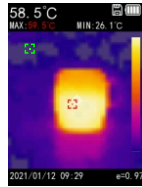

3.4. Photography

When not enter any setting interface, press trigger key to enter the photography interface. Press key to save and press key to give up.

3.5. Unit switching

When the device system is on, press key, press key to select the unit, press key to activate, press key to adjust the unit value, and press key to exit.

The unit includes: °C/°F/ K.

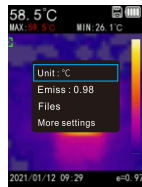

Menu

3.6. Reflectivity

It represents the thermal reflectivity of the surface of the object. When measuring different objects, the numerical value should be adjusted to the corresponding reflectivity, so the temperature measurement will be accurate.

When the system is on, press key, press key to select emissivity, press key to activate, press key to adjust emissivity, and press key to exit. Emissivity: 0.1-1.0 adjustable.

3.7. Shutter spacing

The large interval shutter can make the image clear and the temperature measurement accurate. Industrial temperature measurement interval is generally 3 minutes; temperature measurement interval is generally 1 minute.

3.8. Document management

Before enter any interface, press to select file management, and then you can view pictures option and view video option; select the object to view and enter the interface; if there is no content, prompt no content and return.

Press to view other pictures or videos In the picture viewing state, press the trigger key, you can switch the display of the corresponding visible light image.

In the video viewing state, press the trigger key to play or pause the video. Press to enter the delete current picture option or delete current video option; continue to press to delete, and press to cancel.

4. More settings

4.1. Language switching

In the main menu, press Up and Down keys to move the cursor to more settings, press key, and then press key to select the language, press key to activate, press key to select the language you need, after selection, press key to save and exit.

As shown in the pictures below



4.2. Date and time

In Settings menu, press Up and Down key to select the date and time option; press to enter the modification, select 00 / 01 / 01 00:00 12 (year / month / day/hour/minute: 12-hour or 24-hour time display); press Up and Down key to add or subtract; press to confirm and enter the next item; when all settings were completed, press to save and exit.

4.3. Image Fusion







The technology is used to adjust the fusion position of visible light and infrared light, switch the display mode to dual light fusion mode, and aim the thermal imager at the heat source to be adjusted at the same time; then press  to select settings option, press  to select image fusion option.

Image zooming is used to adjust the magnification of visible light, so as to be consistent with the size of infrared image. Adjust the cursor up and down to select image zooming. Press  key, the interface will disappear, and the red font value will appear in the middle and lower position. Then press   key to adjust until the size of infrared image object is the same as that of visible light image object. Press  to confirm and return.

Left and right adjustment is used to set the left and right cursors of visible light and infrared; up and down adjustment is used to set the up and down coordinates of visible light and infrared. The adjustment method is the same as above.

4.4. Alarm setting



The first line in the upper left corner of the screen represents the maximum temperature of the whole picture, and the second line represents the minimum temperature of the whole picture;

In the alarm setting menu, the high temperature value means that if the temperature of the whole picture exceeds this value, it will alarm (the high temperature value will turn red); the low temperature value means that if the temperature of the whole picture is lower than this value, it will alarm (the low temperature value will turn red); after adjusting these two values, turn on the alarm switch.

4.5. Video

When no setting interface is entered, long press the trigger key until 30s appears in the middle and lower position of the screen, release the trigger key and start recording; the default recording time is 30 seconds, and a prompt box will appear after the recording is finished; the confirm key means save, and the power key means cancel; If you want to end the video recording in advance, just short press  the trigger key again.

4.6. Automatic shutdown

When enter settings interfaces, move the cursor to the auto shutdown option, and press  to set the auto shutdown. There are 15 minutes, 30 minutes, and 1 hour to choose. After setting the auto shutdown time, press  to save and exit.

4.7. Data Output

The system has built-in 2GB storage space, which can play video content of pictures. Insert the TF card into the card and hold it for about 2 seconds, and the TF Card icon will appear in the upper right corner. Select settings - data output option.

4.8. System information

When enter settings interfaces, move the cursor to the system information option, and press to  check the details of the whole device.

4.9. Charging

When power on, the battery symbol in the upper right corner of the screen represents the current power. When the battery symbol turns red, it means that it needs to be charged right now, otherwise it will be automatically shut down due to low power. When charging, use the Micro USB data cable and plug it into the 5V charger for charging.

When the charger powers on, the charging symbol in the upper right corner of the screen turns green and the charging status is dynamically displayed. When power off, the battery symbol in the center of the screen dynamically displays the charging state.

5. Examples of Floor Heating Blockage or Water Leakage Detection



1. Starting from the main gate of hot water pipe (if there are more than 2 channels of hot water pipe), it is recommended to open one of the channels for separate test and carry out the elimination method test.



2. Iron red mode is recommended for thermal imaging, and the red areas on the display represents the location and direction of the hot water pipe.



3. Check the way along the red direction, if the red area disappears, it means it is blocked here. If the red area is in pieces, it means water leakage here.

6. Scene application

1. The investigation of automobile maintenance
2. The investigation of fire-fighting and rescue work
3. Ancient building's repair and maintenance
4. Air and water leakage and other property maintenance
5. The maintenance of living quarters, office building and production power
6. Installation and maintenance of floor heating, radiator and water heater Search for small animals in 7. buildings (including termite control)

7 .Technical indexes

| Thermal imaging technique | |
|----------------------------------|--|
| Language | Chinese / English |
| Thermal imaging resolution | 32*32 (1024 pixels) |
| Electronic shutter | No |
| Visible light camera | 2 megapixels |
| Display resolution | Infrared mode / Infrared edge detection mode / Dual light fusion mode / Visible Light Mode |
| Color palettes | Iron red / cold color / black heat / rainbow / red heat / white heat /Lava |
| Infrared spectral bandwidth | 8~14μm |
| FOV | 33° horizontal |
| I FOV | 18 mrad |
| Thermal imaging sensitivity | 150mk |
| Frame rate | ≤9Hz |
| Image format | BMP |
| Infrared temperature measurement | |
| Temperature measurement range | -20~400°C |
| Basic accuracy | 0°C to 400°C Accuracy: ±1.8% or ±1.8°C, -20 to -0.9 ° C Accuracy: ± 3 ° C, Test conditions, emissivity: 0.95 Ambient temperature: 25±2°C |
| Emissivity | adjustable 0.1~0.99 |
| Measuring resolution | 0.1°C/°F |
| Response time | 150ms |
| Spectral band | 8~14um |

| General parameters | |
|-----------------------------|---|
| Device size (L x W x H) | 60*120*210mm |
| Monitor | 2.4" TFT LCD |
| Display resolution | 320*240 pixels |
| Battery | 3.7V/2600mAh |
| Automatic shutdown function | Yes |
| Certification | CE |
| SD card | 16GB Micro TF card |
| Working temperature | -10°C~45°C, 14°F~113°F |
| Drop proof | 1M (3.28inch) |
| Standard accessories | Charging, manual, USB cable, 16GB micro TF card |

Note: when the measured temperature is not accurate, you can try moving the device and changing the distance from the target to get a close temperature value.

8. Diagram of Series Products



NF-8601S



NF-309



NF-198

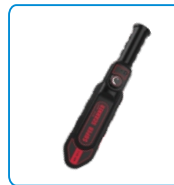

NF-511



NF-2030



NF-488



NF-858C



NF-911



NF-707



NF-711F



NF-5120



NF-271

品号：304-K0501-0090
品名：NF-521说明书-英文V5 20210319
此页无需印刷